

Accessories: Others BOS 18-LT-1

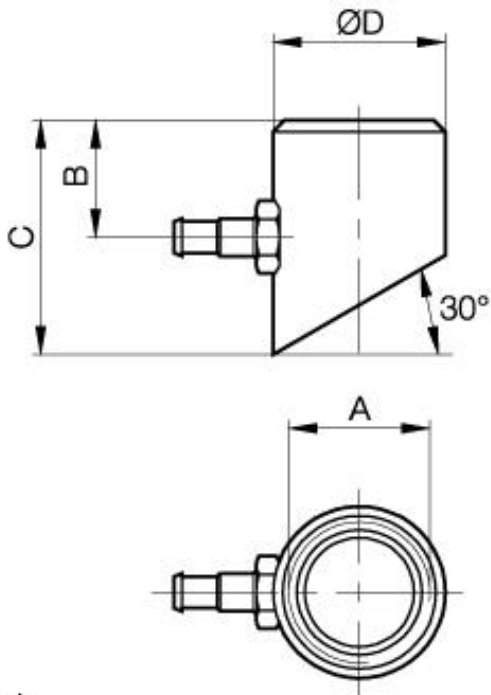

Common Data

Version
Usable with

Air Shield
for Optosensors series BOS 18

Mechanical Data

Measurements WxHxD or Dia x D
Mounting

Ø22 x 30
thread M18

PX0784

Datasheet number::

Definitions see general catalog.
If not otherwise noted, ratings according to
IEC 60947-5-2 (DIN EN60947-5-2)

Balluff GmbH
Schurwaldstrasse 9
73765 Neuhausen a.d.F.
Phone (07158) 173-0 Fax (07158) 5010

Datenblatt by CD-ROM - 04/2007

BALLUFF
sensors worldwide